



USB TO RS232/485/TTL





User Manual







Overview

This is an industrial USB to RS232/485/TTL isolated converter with original FT232RL inside. It features embedded protection circuits such as power isolation, ADI magnetical isolation, and TVS diode, etc. What's more, the USB TO RS232/485/TTL comes with an aluminium alloy enclosure, make it solid and durable to work.





The USB TO RS232/485/TTL is very easy to use, fully automatic transceiving without delay. Due to its fast communication, stability, reliability, and safety, it is an ideal choice for industrial control equipments and/or applications with high communication requirement.

Features

-  USB TO RS232, USB TO RS485, USB TO TTL (UART)
-  Adopt original FT232RL, fast communicating, stable and reliable, better compatibility
-  Onboard unibody power supply isolation, provides stable isolated voltage, needs no extra power supply for the isolated terminal
-  Onboard unibody magnetical isolation, allows signal isolation, high reliability, strong anti-interference, low power consumption

-  Onboard TVS (Transient Voltage Suppressor), effectively suppress surge voltage and transient spike voltage in the circuit, lightning-proof & anti-electrostatic
-  Onboard self-recovery fuse and protection diodes, ensures the current/voltage stable outputs, provides over-current/over-voltage proof, improves shock resistance
-  Fully automatic transceiver circuit with no delay, ensures the USB port communicates with different interfaces fastly and stably, without interfering each other
-  Onboard TTL serial 3.3V/5V voltage translator, config the TTL level via switch
-  Aluminium alloy enclosure with sand blasting and anodic oxidation, CNC process opening, solid and durable
-  3 LEDs for indicating the power and transceiver status
-  High quality USB-B and RS232 connectors, smoothly plug/pul

Specifications

-  Product type: industrial ADI magnetical isolation converter
-  Baudrate: 300-921600bps
-  Host port: USB
-  Device port: RS485/RS232/TTL
-  USB:
 - Operating voltage: 5V
 - Connector: USB-B
 - Protection: 200mA self-recovery fuse, isolated output

- Transmission distance: ~5m

RS485:

- Connector: screw terminal
- Pins: A+, B-, GND
- Direction control: hardware automatic control
- Protection: 600W lightning-proof and surge-suppress, 15KV ESD protection
(reserved 120R balancing resistor solder pads)
- Transmission distance: ~1200m
- Transmission mode: point-to-multipoints (up to 32 nodes, it is recommended to use repeaters for 16 nodes or more)

RS232:

- Connector: DR9 male
- Protection: TVS diode, surge protection, ESD protection
- Transmission distance: ~15m
- Transmission mode: point-to-point

TTL (UART):

- Operating voltage: 3.3V/5V
- Connector: screw terminal
- Pins: TXD, RXD, GND
- Protection: clamp protection diode, over-voltage/negative-voltage proof,
shock resistance
- Transmission mode: point-to-point

 LED indicators:

- PWR: red power indicator, light up when there is USB connection and voltage is detected
- TXD: green TX indicator, light up when the USB port sends data
- RXD: blue RX indicator, light up when the device ports send data back

 Operating environment:

- Temperature: -15°C ~ 70°C
- Humidity: 5%RH ~ 95%RH

 Operating system: Windows 10 / 8.1 / 8 / 7 / XP

Note: There is a pad reserved for 120R balancing resistance. Recommend you to weld 120Ω resistors to the first and last devices if you connect many devices at the same time.

CONECTENT

Overview.....	1
Features.....	1
Specifications.....	2
Driver Installation.....	6
Testing.....	10
Interfaces.....	10
RS232.....	10
RS485.....	11
TTL.....	12

Driver Installation

1. Connect module to PC, if you find that a yellow exclamation symbol occur as below,

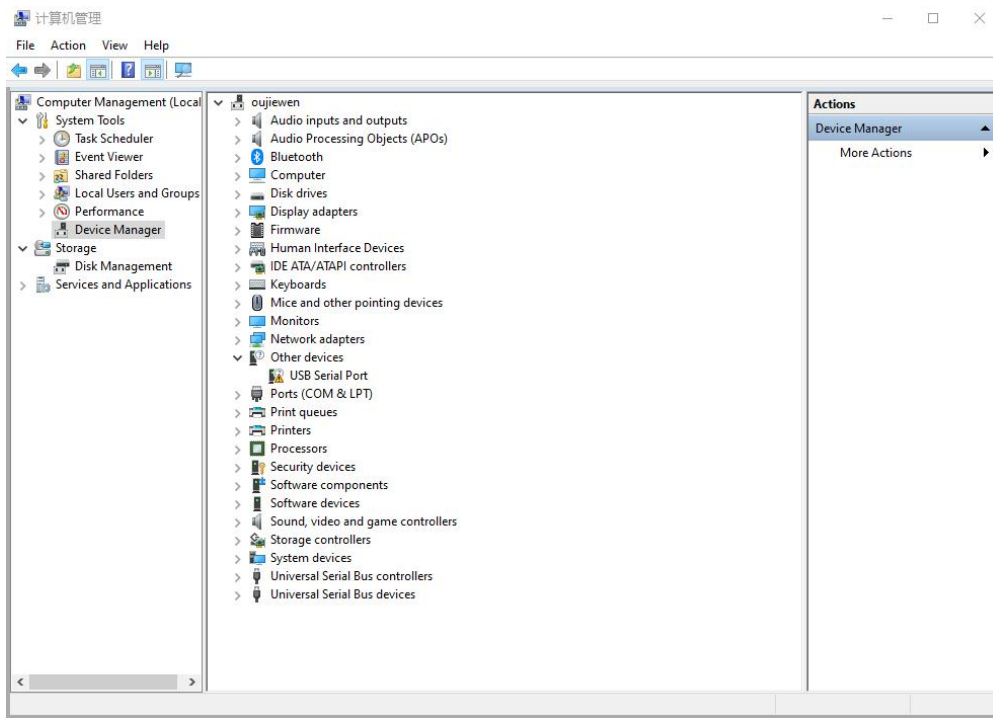

2. Download the driver from Waveshare Wiki

https://www.waveshare.com/wiki/USB_TO_RS232/485/TTL#Resources

3. After downloading, extract and install it

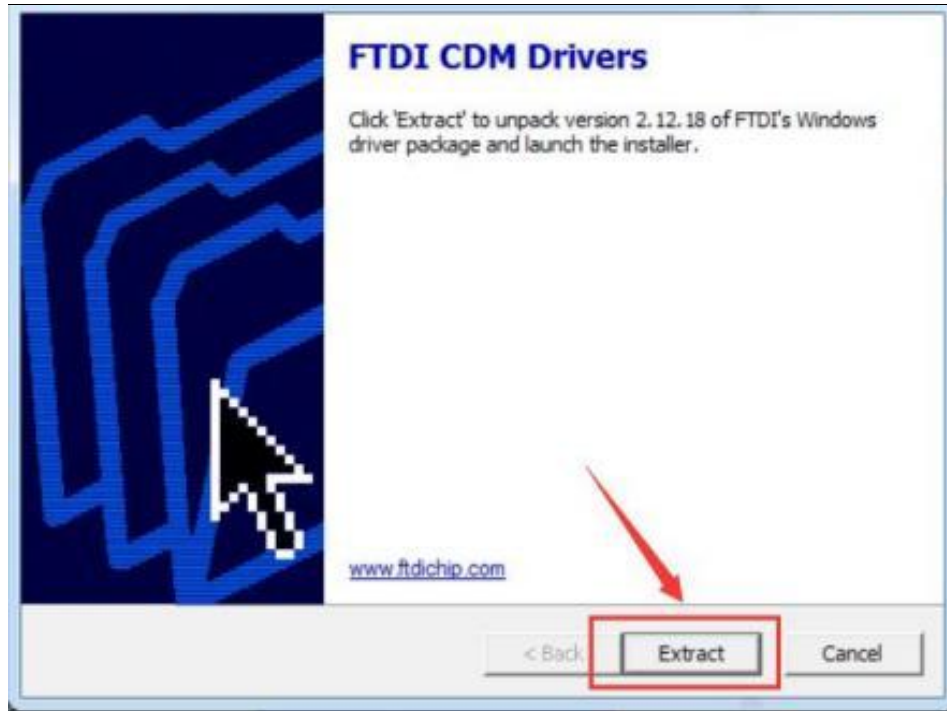

4. Click Extract:

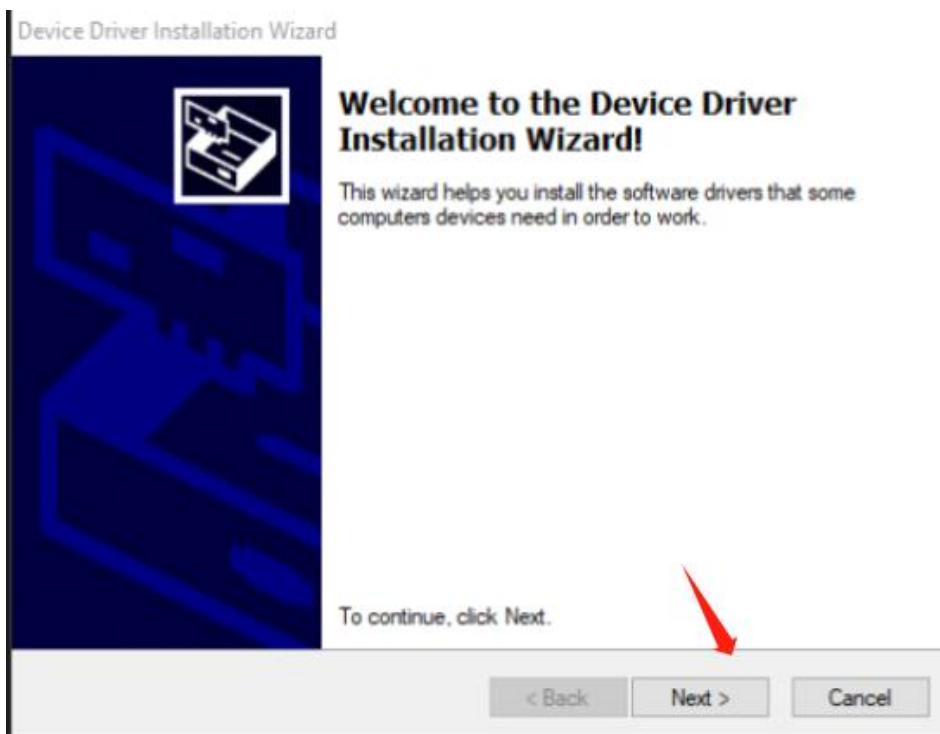

5. Click Next Step:

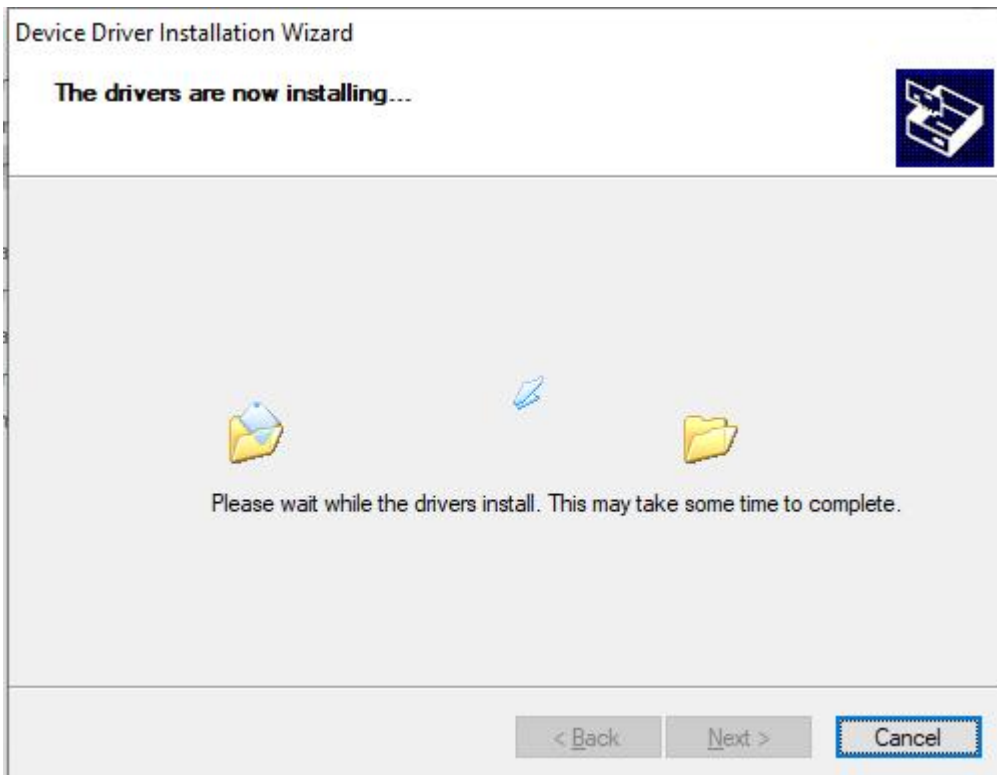
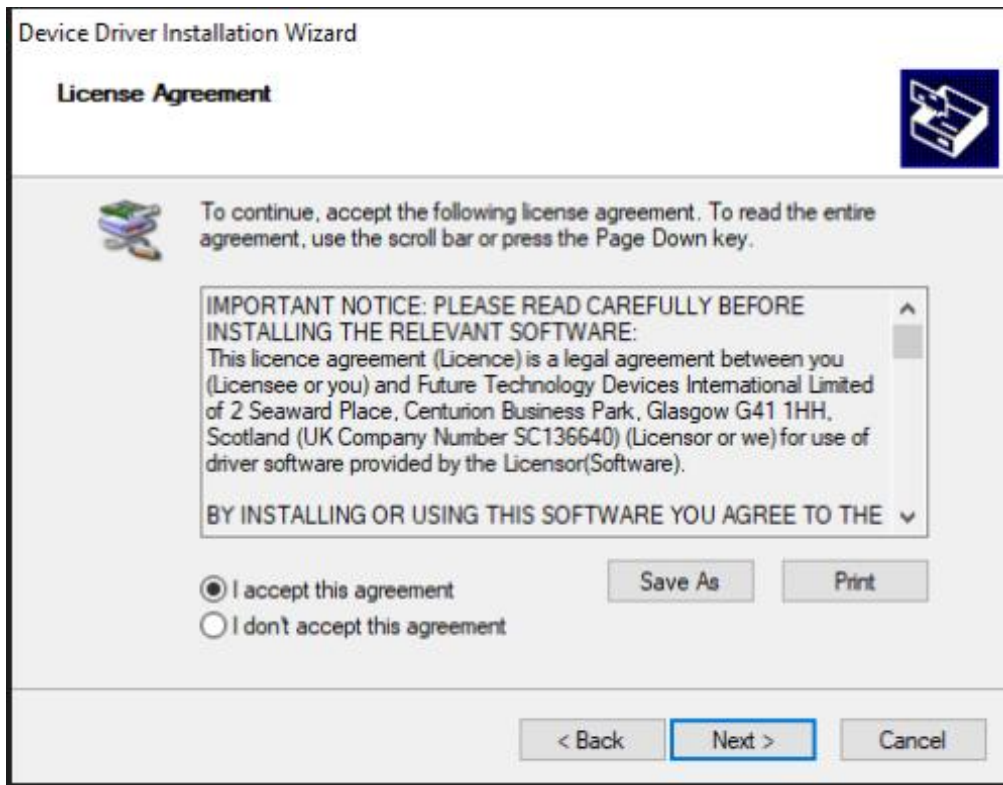



6. After installing, you can check if the yellow exclamation symbol disappear.

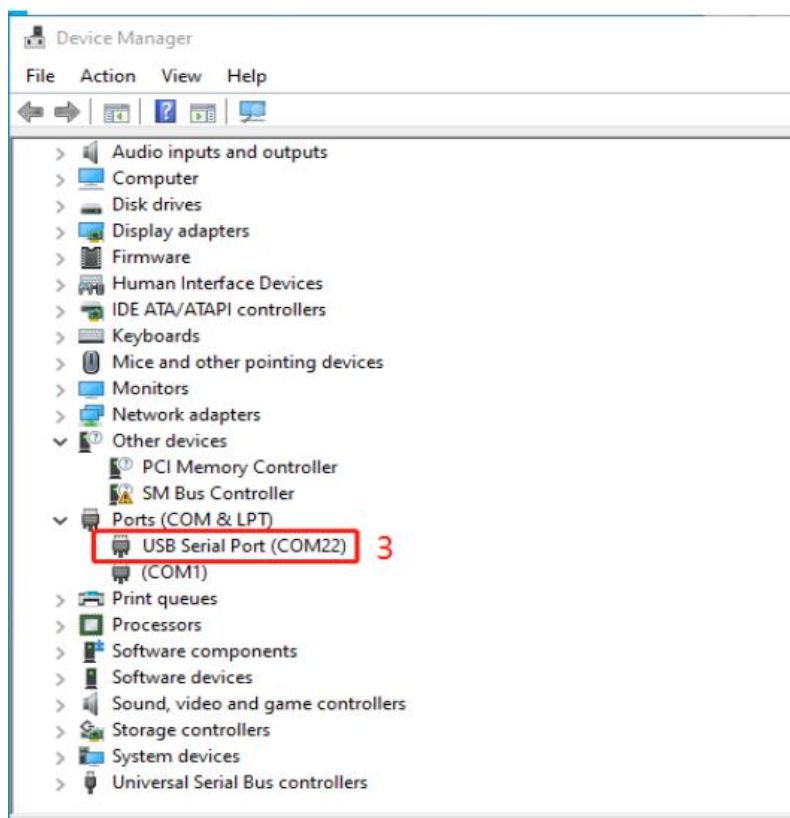

Testing

INTERFACES

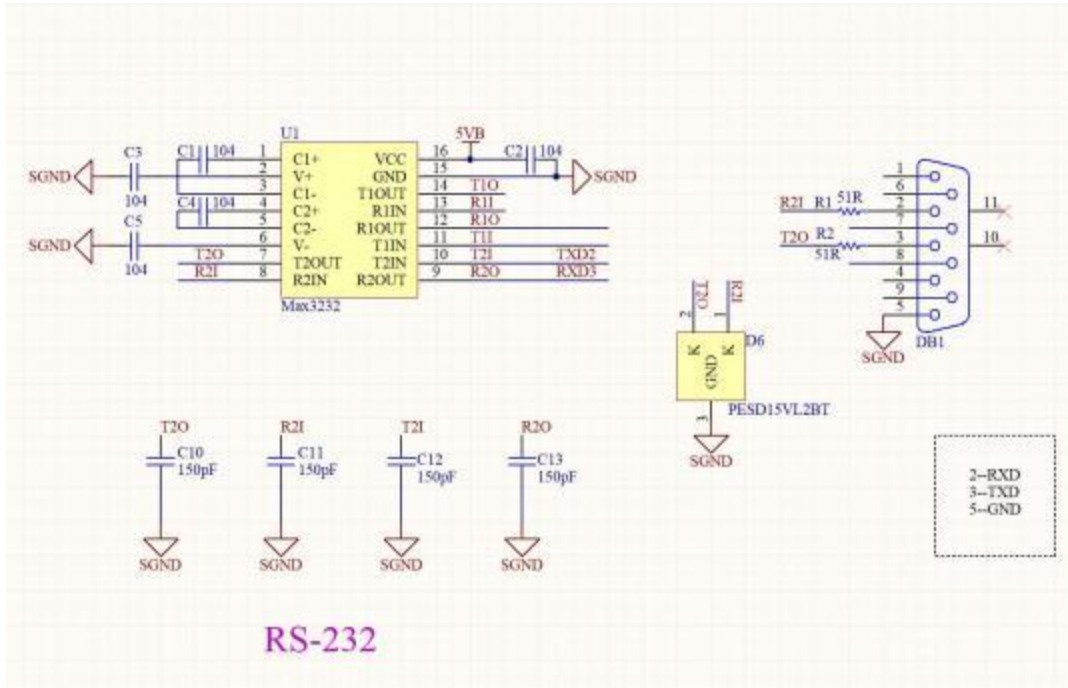

RS232

Connect RS232 and USB interface to PC. Open two Serial Assistance Software and set them with same baudrate, test them as below:



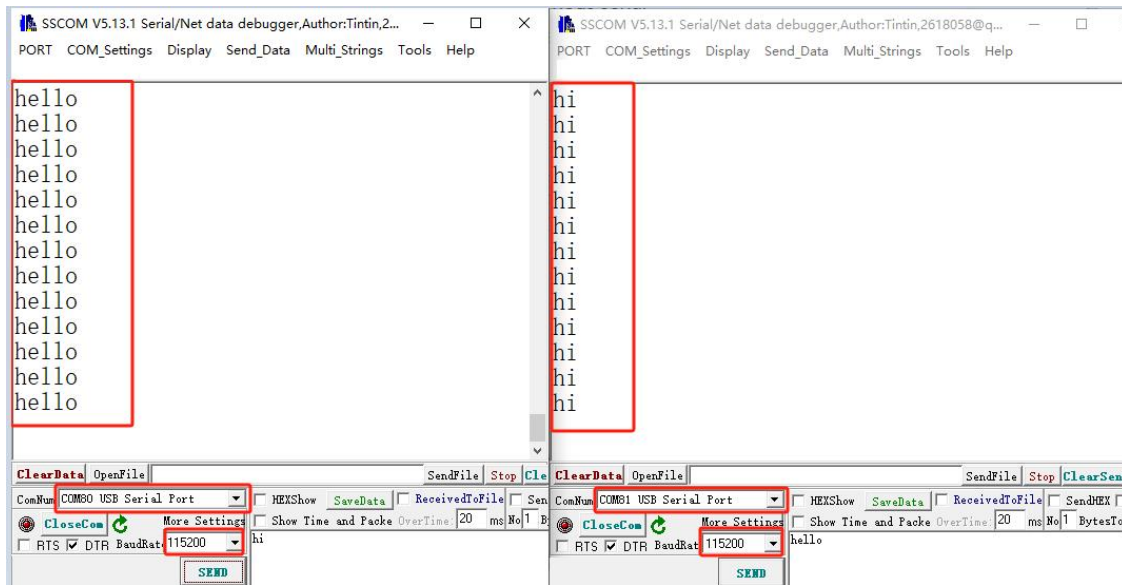

RS485

Connect RS485 interface to RS485 interface of target board (here we use our RS485 board to test), A to A and B to B. Open two Serial Software on PC and test it. (Note that RS485 Board should pull-high RSE to send data and pull0download it to receive))

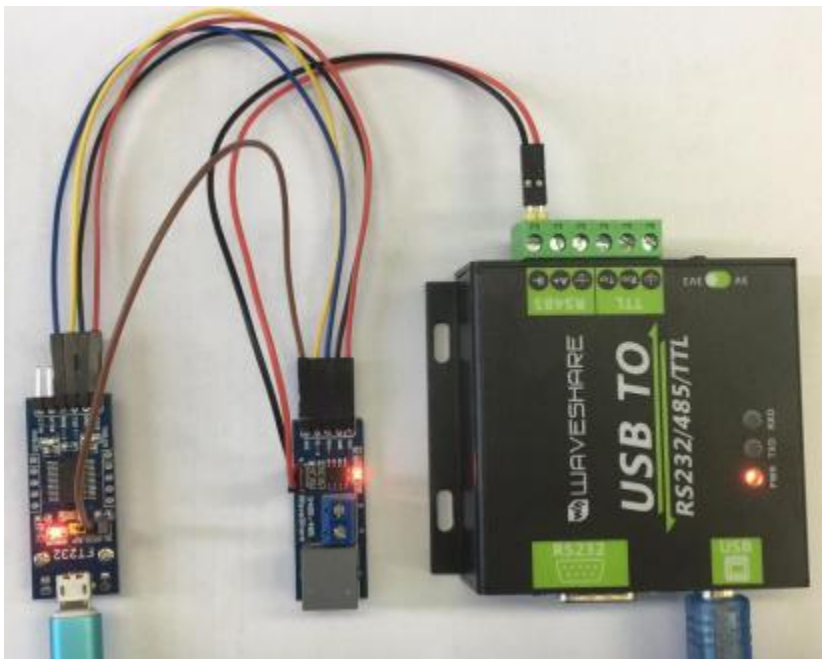

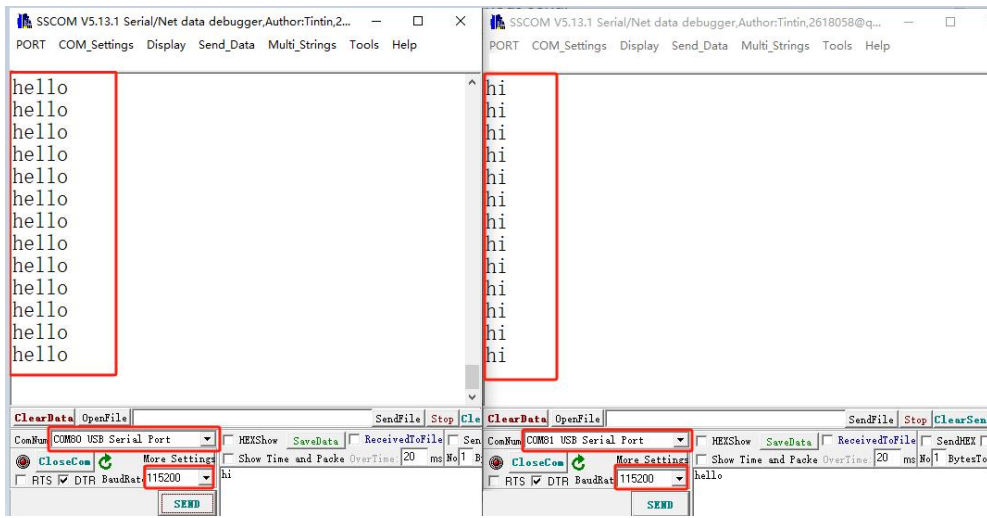

TTL

Connect TTL interface to other UART board and connect to PC, open two Serial software and test:



